



AESCULAP® POWER SYSTEMS

CATALOG 2021

ELAN 4 and Acculan 4

CONTENT

ELAN 4

- ELAN 4 electro
 - ELAN 4 Accessories
-

Acculan 4

- Acculan 4 Et Acculan 4 Small Drill
 - Acculan 4 Electro
 - Acculan 4 Accessories
-

PROCESSING

- Sterilit® Power Systems
 - Processing
-

OTHERS

- Tool Attachments Overview
 - Signs Et Symbols
 - Brochures
 - Index
-

All measurements and technical data listed in this catalogue are approximate as they are subject to normal manufacturing tolerances and to technical modifications.

AESCLAP® ELAN 4

PRECISION. PERFORMANCE. PLEASURE.

With a new technical concept ELAN 4 addresses important requirements of the surgeon and all parties involved in handling power systems in the hospital.

- Convenient and reliable grip
- Powerful, precise and reliable work
- Easy to set up and simple to use



AESCLAP[®] ELAN 4

ELAN 4 electro

ELECTRIC HIGHSPEED SYSTEM



ELAN 4 electro BASIC COMPONENTS

GA800

ELAN 4 electro CONTROL UNIT

with irrigation pump; touch screen;
power cord not included
pump flow 0 - 65 ml/min

100 - 240 V AC; 50/60 Hz;
330 x 330 x 200 mm; 9,500 g

consisting parts:
GD412804 bottle holder

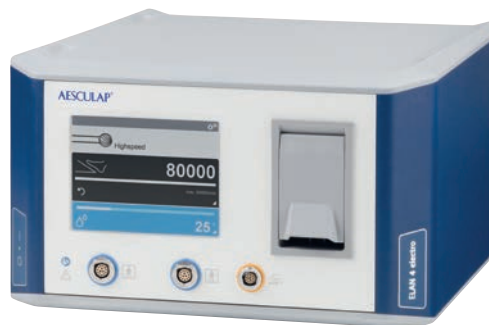

GA808

ELAN 4 electro FOOT CONTROL

protection type IPX8; anaesthetic
proof class AP

5.0 m;
245 x 144 x 76 mm; 2,240 g



GA810

ELAN 4 electro WIRELESS FOOT CONTROL

for use with ELAN 4 electro applied
parts

271 x 266 x 85 mm; 3,800 g

Requires control unit with software
version V3.00.



GA806

GB073R

ELAN 4 electro MOTOR CABLE

for use with ELAN 4 electro applied
parts

4.0 m; 270 g

consisting parts:
GB600860 Sterilit® spray adaptor
ELAN 4 electro



AESCULAP® ELAN 4

ELAN 4 electro

BASIC COMPONENTS, PERFORATOR DRIVER & LOWSPEED MOTOR

GA804

GB073R

ELAN 4 electro MOTOR CABLE WITH HAND SWITCH

for use with ELAN 4 electro applied parts

4.0 m; 370 g

consisting parts:
GB600860 Sterilit® spray adaptor
ELAN 4 electro



GA805

GB073R

ELAN 4 electro MOTOR CABLE WITH HAND CONTROL

for use with ELAN 4 electro applied parts

4.0 m; 370 g

consisting parts:
GB600860 Sterilit® spray adaptor
ELAN 4 electro



GA822

GB076R

ELAN 4 electro PERFORATOR DRIVER

for use with cranial perforators with Hudson shank

180 W; 0 - 1,200 rpm; 250 Ncm;
166 x 35 mm; 410 g



GA824

GB077R

ELAN 4 electro LOWSPEED MOTOR with intra coupling

with intra coupling

180 W; 0 - 40,000* rpm;
10 Ncm; 123 x 23 mm; 150 g

* Requires control unit with software version V3.00. With lower versions the motor runs max. 20,000 rpm.



ELAN 4 electro CRANIOTOME & ATTACHMENTS

GA849

GB085R

ELAN 4 electro CRANIOTOME AND MULTIFUNCTION HANDPIECE

2-ring coding; for use with
dura guards and holding sleeves
GB941R - GB947R; spray nozzle
GA259SU (not included)

140 W; ↻ ↺; 0 - 80,000 rpm; 2.2 Ncm;
156 x 17 mm; 📖 121 g



GB941R

GB719R

ELAN 4 DURA GUARD PEDIATRIC

fixed; 1 dot coding;
for craniotome and multifunction
handpieces GA749, GA849

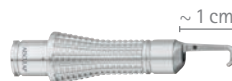

GB942R

GB719R

ELAN 4 DURA GUARD STANDARD

fixed; 2 dot coding;
for craniotome and multifunction
handpieces GA749, GA849

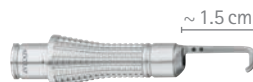

GB943R

GB719R

ELAN 4 DURA GUARD LONG

fixed; 3 dot coding;
for craniotome and multifunction
handpieces GA749, GA849



GB945R

GB719R

ELAN 4 HOLDING SLEEVE

for craniotome and multifunction
handpieces GA749, GA849



GB947R

GB719R

ELAN 4 DURA GUARD STANDARD

turnable; 2 dot coding;
for craniotome and multifunction
handpieces GA749, GA849



AESCULAP® ELAN 4

ELAN 4 electro

1-RING HIGHSPEED HANDPIECES

GA861

GB083R

ELAN 4 electro 1-RING HANDPIECE
L4

1-ring coding;
spray nozzle GA261SU (not included)
140 W; ↻ ↻; 0 - 80,000 rpm; 2.2 Ncm;
152 x 16 mm; 80 g



GA862

GB083R

ELAN 4 electro 1-RING HANDPIECE
L7

1-ring coding;
spray nozzle GA262SU (not included)
140 W; ↻ ↻; 0 - 80,000 rpm; 2.2 Ncm;
177 x 16 mm; 83 g



GA863

GB083R

ELAN 4 electro 1-RING HANDPIECE
L10

1-ring coding;
spray nozzle GA263SU (not included)
140 W; ↻ ↻; 0 - 80,000 rpm; 2.2 Ncm;
206 x 16 mm; 87 g

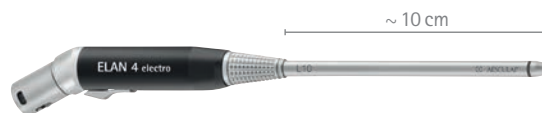

GA864

GB083R

ELAN 4 electro 1-RING HANDPIECE
L13

1-ring coding;
spray nozzle GA264SU (not included)
140 W; ↻ ↻; 0 - 80,000 rpm; 2.2 Ncm;
237 x 16 mm; 91 g





ELAN 4 electro

2-RING HIGH SPEED HANDPIECES



GA865**GB083R**

ELAN 4 electro 2-RING HANDPIECE
L7

2-ring coding;
spray nozzle GA265SU (not included)
140 W;  ; 0-80,000 rpm; 2.2 Ncm;
176 x 16 mm;  89 g



**GA866****GB083R**

ELAN 4 electro 2-RING HANDPIECE
L10

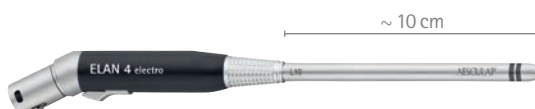
2-ring coding;
spray nozzle GA266SU (not included)
140 W;  ; 0-80,000 rpm; 2.2 Ncm;
206 x 16 mm;  95 g



**GA867****GB083R**

ELAN 4 electro 2-RING HANDPIECE
L13

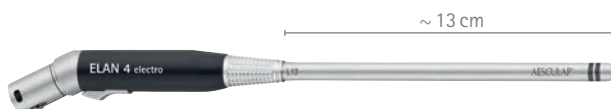
2-ring coding;
spray nozzle GA267SU (not included)
140 W;  ; 0-80,000 rpm; 2.2 Ncm;
236 x 16 mm;  100 g



**GA868****GB083R**

ELAN 4 electro 2-RING HANDPIECE
L17

2-ring coding;
spray nozzle GA268SU (not included)
140 W;  ; 0-80,000 rpm; 2.2 Ncm;
276 x 16 mm;  108 g

**GA869****GB083R**

ELAN 4 electro 2-RING HANDPIECE
L22

2-ring coding;
spray nozzle GA269SU (not included)
140 W;  ; 0-80,000 rpm; 2.2 Ncm;
326 x 16 mm;  118 g



AESCULAP® ELAN 4

ELAN 4 electro

MIS HANDPIECE & HANDPIECE SHAFTS



GA860**GB084R****ELAN 4 electro MIS HANDPIECE**for use with handpiece shafts
GB920R - GB927R140 W; ↖ ↗; 0 - 80,000 rpm;
2.2 Ncm; 118 x 17 mm; 100 g**GB920R****GB723R****ELAN 4 MIS HANDPIECE SHAFT
L10 STRAIGHT**

spray nozzle GB796SU (not included)

**GB921R****GB723R****ELAN 4 MIS HANDPIECE SHAFT
L10 CURVED**

spray nozzle GB796SU (not included)

**GB922R****GB723R****ELAN 4 MIS HANDPIECE SHAFT
L10 HEAVY CURVED**

spray nozzle GB796SU (not included)

**GB925R****GB723R****ELAN 4 MIS HANDPIECE SHAFT
L13 STRAIGHT**

spray nozzle GB797SU (not included)

**GB926R****GB723R****ELAN 4 MIS HANDPIECE SHAFT
L13 CURVED**

spray nozzle GB797SU (not included)

**GB927R****GB723R****ELAN 4 MIS HANDPIECE SHAFT
L13 HEAVY CURVED**

spray nozzle GB797SU (not included)



AESCLAP[®] ELAN 4

ELAN 4 electro
SAWS



GA836**GB086R**

ELAN 4 electro MICRO SAGITTAL SAW
 spray nozzle GA258SU (not included)
 180 W; 0 - 20,000 rpm; 161 x 23 mm;
 \sphericalangle 7°; \updownarrow 190 g

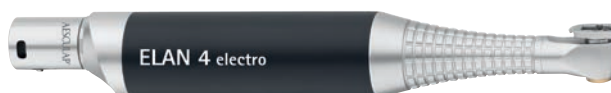
**GA837****GB087R**

ELAN 4 electro MICRO
 RECIPROCATING SAW
 spray nozzle GA258SU (not included)
 180 W; 0 - 20,000 rpm; 184 x 23 mm;
 \updownarrow 1.3 mm; \updownarrow 198 g

**GA831****GB088R**

ELAN 4 electro SAGITTAL SAW
 spray nozzle GA258SU (not included)
 180 W; 0 - 20,000 rpm; 129 x 23 mm;
 \sphericalangle 4.5°; \updownarrow 220 g

**GA832****GB087R**

ELAN 4 electro RECIPROCATING SAW
 spray nozzle GA258SU (not included)
 180 W; 0 - 20,000 rpm; 194 x 23 mm;
 \updownarrow 2.5 mm; \updownarrow 238 g

**GA833****GB088R**

ELAN 4 electro TRANSVERSAL SAW
 spray nozzle GA258SU (not included)
 180 W; \sphericalangle \sphericalangle ; 0 - 20,000 rpm; 10 Ncm;
 130 x 23 mm; \sphericalangle 10°; \updownarrow 185 g
 to be used with saw blade shafts
 GP580R, GP582R, GP586R and GP590R

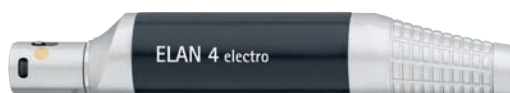

AESCULAP® ELAN 4

ELAN 4 electro
DRILL



GA844**GB482R****ELAN 4 electro DRILL**

with oscillating and tapping mode



200 W;  3.2 mm;
130 x 27 x 122 mm;  800 g

consisting parts:

GA344244 K-wire protection guide





GA344211 rinsing adaptor

GB600880 Sterilit® spray adaptor

Requires control unit with software
version V3.00.**GB870R****GB716R****INTRAMEDULLARY REAMER
ATTACHMENT**with Jacobs chuck 0.5 - 7.4 mm,
not for use with acetabulum reamers0 - 320 rpm; 6.5 Nm;  3.2 mm;
105 x 29 mm;  230 g

consisting parts:

key GA031R

**GB871R****GB716R****INTRAMEDULLARY REAMER
ATTACHMENT**with large AO chuck,
not for use with acetabulum reamers0 - 320 rpm; 6.5 Nm;  3.2 mm;
88 x 29 mm;  170 g**GB872R****GB716R****INTRAMEDULLARY REAMER
ATTACHMENT**with Hudson/Zimmer chuck,
not for use with acetabulum reamers0 - 320 rpm; 6.5 Nm;  3.2 mm;
86 x 25 mm;  150 g

AESFULAP® ELAN 4

ELAN 4 electro ATTACHMENTS

GB881R

GB716R

DRILL ATTACHMENT

with Jacobs chuck 0.5 - 7.4 mm

0 - 1,250 rpm; 2 Nm;  3.2 mm;
89 x 29 mm;  163 g

consisting parts:
key GA031R



GB882R

GB716R

DRILL ATTACHMENT

with Jacobs chuck 0.5 - 4 mm

0 - 1,250 rpm; 2 Nm;  3.2 mm;
76 x 22 mm;  100 g

consisting parts:
key GA062R





GB884R

GB716R

DRILL ATTACHMENT

with small AO chuck

0 - 1,250 rpm; 2 Nm;  2.8 mm;
60 x 22 mm;  66 g





GB886R

GB716R

DRILL ATTACHMENT

with AESFULAP® hexagonal chuck

0 - 1,250 rpm; 2 Nm;  3.2 mm;
57 x 24 mm;  67 g





GB887R

GB716R

DRILL ATTACHMENT

with Dental shank

0 - 1,250 rpm; 2 Nm;  1.8 mm;
56 x 22 mm;  50 g



GB878R**GB716R****ADAPTOR**

for Synthes radiolucent drive 511.300

0 - 1,250 rpm; 2 Nm;
111 x 27 mm; 181 g**GB894R****GB716R****K-WIRE ATTACHMENT**

for K-wires from 0.6 - 3.2 mm

0 - 1,250 rpm; 3.2 mm;
92 x 27 x 124 mm; 179 g**GB891R****GB716R****SAGITTAL SAW ATTACHMENT**for "L-sagittal" sawblades with a
maximum usable length of 50 mm0 - 15,750 rpm; 74 x 33.5 mm;
4.5°; 179 g**GB892R****GB716R****RECIPROCATING SAW ATTACHMENT**

for reciprocating sawblades

0 - 15,750 rpm; 135 x 24.5 mm;
2.5 mm; 166 g

AESCULAP® ELAN 4



ELAN 4 electro ATTACHMENTS

GB896R

GB716R

SCREW ATTACHMENT

with small AO chuck

0 - 165 rpm; 12 Nm;  1.7 mm;
95 x 28 x 129.5 mm;  235 g





GB897R

GB716R

SCREW ATTACHMENT

with AESCULAP® hexagonal chuck

0 - 165 rpm; 12 Nm;  1.7 mm;
95 x 28 x 129.5 mm;  231 g



AESCLAP® ELAN 4

ELAN 4 ACCESSORIES

GB861P

GB727R

ELAN 4 LENGTH REDUCTION SLEEVE
for use with 1-ring handpieces



GB863P

GB727R

ELAN 4 LENGTH REDUCTION SLEEVE
for use with 2-ring handpieces



GB862P

GB727R

ELAN 4 MIS SLEEVE
for use with 1-ring handpieces



GB866R

ELAN 4 LATERAL BURR GUARD
for use with 1-ring handpieces and
burrs up to 4.5 mm diameter



TE780

POWER CORD
Europe,  1.5 m

TE730

POWER CORD
Europe,  5.0 m

TE734

POWER CORD
UK,  5.0 m

TE735

POWER CORD
USA, Canada, Japan,  3.5 m



GA395SUsterile  

ELAN 4 electro DISPOSABLE TUBE SET

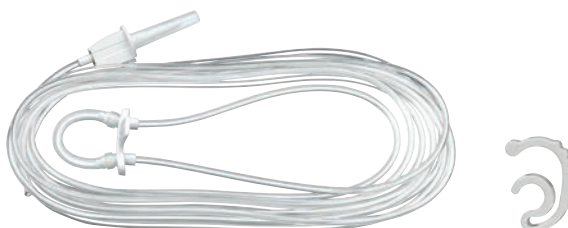
**ELAN 4 SPAY NOZZELS**sterile **GA259SU**

for craniotome attachment

GA261SU

for 1-ring handpiece L4

GA262SU

for 1-ring handpiece L7

GA263SU

for 1-ring handpiece L10

GA264SU

for 1-ring handpiece L13

GA265SU

for 2-ring handpiece L7

GA266SU

for 2-ring handpiece L10

GA267SU

for 2-ring handpiece L13

GA268SU

for 2-ring handpiece L17

GA269SU

for 2-ring handpiece L22

GB796SU

for MIS handpiece shafts L10

GB797SU

for MIS handpiece shafts L13

**GA258SU**

for saws



AESCULAP® Acculan 4

LOOK. FEEL. EXPERIENCE.

Acculan 4 the battery-operated power system for orthopaedics, traumatology, cardiothoracic surgery and dermatology

- Powerful
- Longevity – Exclusion of battery and electronic control from sterilization process
- Easy handling – Titanium housing allows mechanical alkaline reprocessing



AESCULAP® Acculan 4

DRILL & ATTACHMENTS

GA330

GB495R

Acculan 4 DRILL AND REAMER

250 W;  4.0 mm;
207 x 121 x 55 mm;  1,250 g

consisting parts:

GA678 sterile funnel

GA672207 K-wire protection sleeve

GA672211 rinsing adaptor

GB600840 Sterilit® spray adaptor

Acculan

Lid GA675 and NiMH battery GA676 to be ordered separately.

Measurements and weight are including battery and lid.





GB620R

GB496R

Acculan 4 DRILL ATTACHMENT

with Jacobs chuck keyless 0.5 - 7.4 mm

0 - 1,000 rpm; 5.0 Nm;  4.0 mm;
133 x 35 mm;  397 g



GB621R

GB496R

Acculan 4 DRILL ATTACHMENT

with Jacobs chuck 0.5 - 7.4 mm

0 - 1,000 rpm; 5.0 Nm;  4.0 mm;
118 x 35 mm;  300 g

consisting parts:

key GA031R





GB623R

GB496R

Acculan 4 DRILL ATTACHMENT

with small AO chuck

0 - 1,250 rpm; 4.0 Nm;  2.8 mm;
90 x 35 mm;  210 g





ATTACHMENTS

GB639R

GB496R

Acculan 4 DRILL ATTACHMENT

with Jacobs chuck 0.5 – 4.0 mm

0 – 1,250 rpm; 4.0 Nm;  4.0 mm;
105 x 35 mm;  243 g

consisting parts:
key GA062R



GB645R

GB496R

Acculan DRILL ATTACHMENT

for Synthes radiolucent drive 511.300

0 – 900 rpm; 110 x 35 mm;  225 g





GB663R

GB496R

Acculan 4 DRILL ATTACHMENT

with trinkle chuck

0 – 1,000 rpm; 5.0 Nm;  4.0 mm;
93 x 35 mm;  217 g





GB664R

GB496R

Acculan 4 DRILL ATTACHMENT

with AESCULAP® hexagonal chuck

0 – 1,000 rpm; 5.0 Nm;  4.0 mm;
86 x 35 mm;  225 g





GB665R

GB496R

Acculan 4 DRILL ATTACHMENT

with Hudson / Zimmer chuck

0 – 1,000 rpm; 5.0 Nm;  4.0 mm;
100 x 35 mm;  230 g



AESCULAP® Acculan 4



ATTACHMENTS

GB657R

GB496R

Acculan 4 INTRAMEDULLAR ATTACHMENT

with large AO chuck

0 - 370 rpm; 12.0 Nm;  4.0 mm;
108 x 35 mm;  300 g





GB667R

GB496R

Acculan 4 REAMER ATTACHMENT

with Jacobs chuck 0.5 - 7.4 mm chuck

0 - 250 rpm; 19.0 Nm;  4.0 mm;
133 x 35 mm;  280 g

consisting parts:
key GA031R

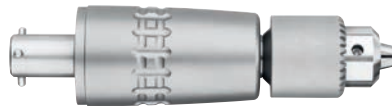



GB668R

GB496R

Acculan 4 REAMER ATTACHMENT

with large AO chuck

0 - 250 rpm; 19.0 Nm;  4.0 mm;
108 x 35 mm;  300 g





GB669R

GB496R

Acculan 4 REAMER ATTACHMENT

with Hudson / Zimmer chuck

0 - 250 rpm; 19.0 Nm;  4.0 mm;
118 x 35 mm;  300 g





GB670R

GB496R

Acculan 4 REAMER ATTACHMENT

with Harris chuck

0 - 250 rpm; 19.0 Nm;  4.0 mm;
106 x 35 mm;  290 g



GB660R

GB496R

Acculan SAGITTAL SAW ATTACHMENT

for Acculan rapid action saw blades
with a maximum useable length of
50 mm

«» 0 - 17,000 rpm; \sphericalangle 4°47';
89 x 36 x 44 mm; ♁ 270 g



GB641R

GB496R

Acculan K-WIRE ATTACHMENT

for K-wires from 0.6 - 4.0 mm

0 - 1,250 rpm; 93 x 36 x 137 mm;
 ♁ 285 g



AESCULAP® Acculan 4

OSCILLATING SAWS

GA331

GB495R

Acculan 4 OSCILLATING SAW

250 W; \leftrightarrow 0 - 13,000 rpm; \sphericalangle 4.1°;
211 x 177 x 55 mm; \updownarrow 1,600 g

consisting parts:
GA678 sterile funnel

Lid GA675 and NiMH battery GA676 to
be ordered separately.

Measurements and weight are including
battery and lid.



GA336

GB498R

Acculan 4 OSCILLATING SAW STRAIGHT

250 W; \leftrightarrow 0 - 13,000 rpm; \sphericalangle 4.1°;
290 x 55 x 84 mm; \updownarrow 1,480 g

consisting parts:
GA678 sterile funnel

Lid GA675 and NiMH battery GA676 to
be ordered separately.

Measurements and weight are including
battery and lid.



GA337

GB498R

Acculan 4 OSCILLATING STERNUM SAW

250 W; \leftrightarrow 0 - 13,000 rpm; \sphericalangle 4.1°;
290 x 55 x 84 mm; \updownarrow 1,480 g

consisting parts:
GA678 sterile funnel

Lid GA675 and NiMH battery GA676 to
be ordered separately.

Measurements and weight are including
battery and lid.



RECIPROCATING SAW

GA334

GB495R

Acculan 4 RECIPROCATING SAW

250 W; ↔ 0 - 15,000 rpm; ↓ 3.2 mm;
207 x 180 x 55 mm; ⚖ 1,540 g

consisting parts:

GA678 sterile funnel

GB440215 cleaning plate

GA674890 cleaning adaptor

Lid GA675 and NiMH battery GA676 to be ordered separately.

Measurements and weight are including battery and lid.



GB436R

GB686R

PROTECTION GUIDE

for use with GA334 and saw blade
GC761R



AESCULAP® Acculan 4

DERMATOME

GA340

GB498R

Acculan 4 DERMATOME

width keyless adjustable;
thickness adjustable (1 / 10 mm steps);
cutting thickness: 0.2 - 1.2 mm;
cutting width: max. 78 mm;
suitable blades: GB228R
(to be ordered separately)

250 W; ↔ 0 - 6,500 rpm; ↑↓ 3.1 mm;
277 x 113 x 83 mm; ⚖ 1,650 g

consisting parts:
GA678 sterile funnel

Lid GA675 and small Li-Ion battery
GA346 to be ordered separately.

Measurements and weight are including
battery and lid.



GA341

GB498R

Acculan 4 DERMATOME 0.1 MM

width keyless adjustable;
thickness adjustable (1 / 10 mm steps);
cutting thickness: 0.1 - 1.1 mm;
cutting width: max. 78 mm;
suitable blades: GB228R
(to be ordered separately)

250 W; ↔ 0 - 6,500 rpm; ↑↓ 3.1 mm;
277 x 113 x 83 mm; ⚖ 1,650 g

consisting parts:
GA678 sterile funnel

Lid GA675 and small Li-Ion battery
GA346 to be ordered separately.

Measurements and weight are including
battery and lid.



BA720R

GB688R

SKIN GRAFT MESHER

for use in combination with skin graft
carriers BA721 (1:1.5) / BA722 (1:3) /
BA723 (1:6)

150 x 195 x 105 mm; ⚖ 4,600 g

consisting parts:
BA725R cutting roller
BA726R ratchet wrench



AESCULAP® Acculan 4

LOOK. FEEL. EXPERIENCE.

Acculan 4 small drill – the smallest member of the Acculan 4 family can be used for small fragment Osteosynthesis as well as for reamed intramedullary nailing.

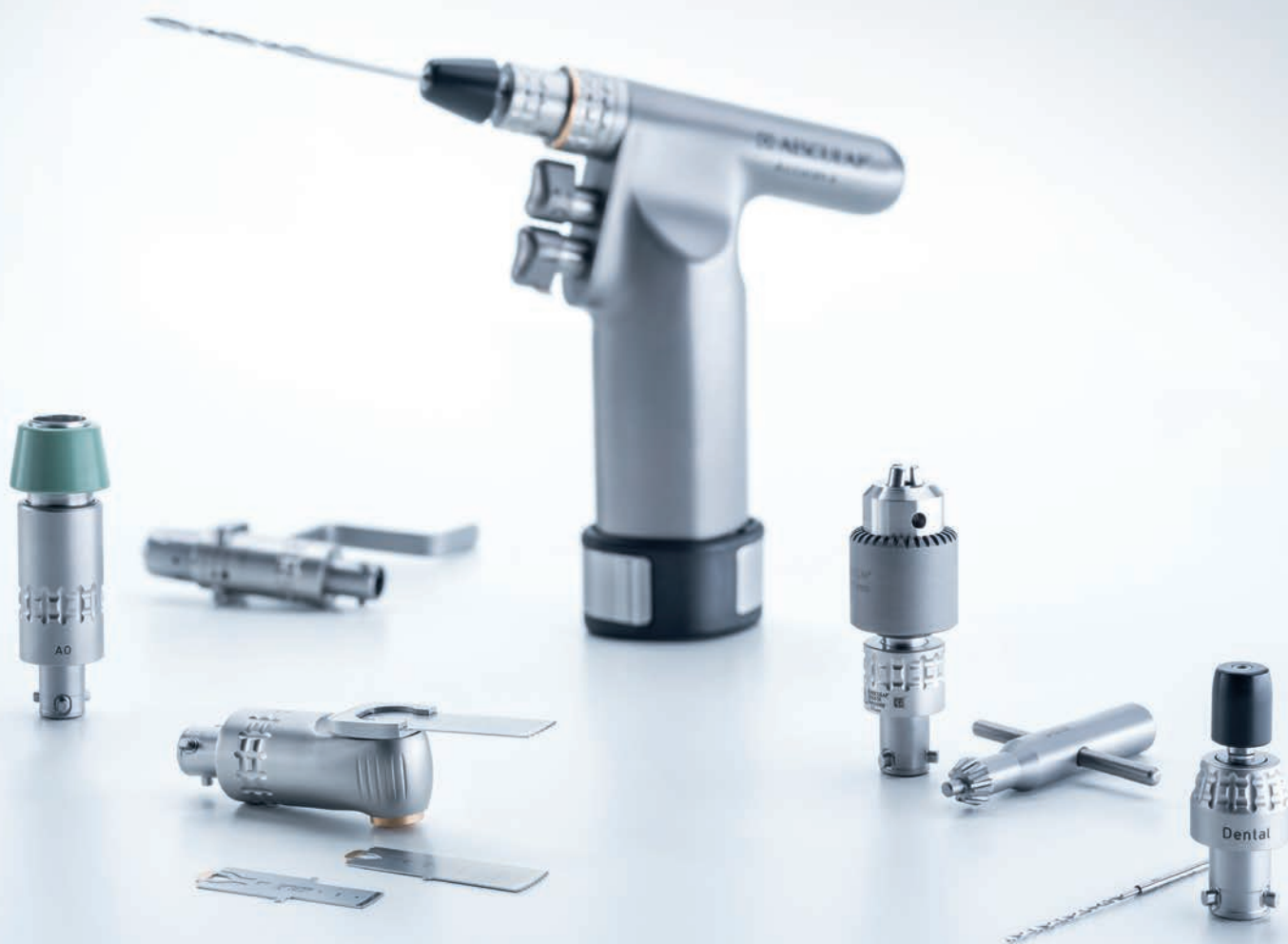

AESCULAP® Acculan 4

SMALL DRILL



DRILL & ATTACHMENTS

GA344

GB482R

Acculan 4 SMALL DRILL

with oscillating and tapping mode;
not for use with acetabulum reamers

85 W;  ;  3.2 mm;
177 x 124 x 55 mm;  840 g

consisting parts:

GA678 sterile funnel

GA344244 K-wire protection guide

GA344211 rinsing adaptor

GB600880 Sterilit® spray adaptor

Lid GA675 and small Li-Ion battery
GA346 to be ordered separately.

Measurements and weight are including
battery and lid.





GB870R

GB716R

INTRAMEDULLARY REAMER ATTACHMENT

with Jacobs chuck 0.5 - 7.4 mm,
not for use with acetabulum reamers

0 - 320 rpm; 5 Nm;  3.2 mm;
105 x 29 mm;  230 g

consisting parts:

key GA031R



GB871R

GB716R

INTRAMEDULLARY REAMER ATTACHMENT

with large AO chuck,
not for use with acetabulum reamers

0 - 320 rpm; 5 Nm;  3.2 mm;
88 x 29 mm;  170 g





GB872R

GB716R

INTRAMEDULLARY REAMER ATTACHMENT

with Hudson/Zimmer chuck,
not for use with acetabulum reamers

0 - 320 rpm; 5 Nm;  3.2 mm;
86 x 25 mm;  150 g





SMALL DRILL ATTACHMENTS

GB881R

GB716R

DRILL ATTACHMENT

with Jacobs chuck 0.5 - 7.4 mm

0 - 1,250 rpm; 1.5 Nm;  3.2 mm;
89 x 29 mm;  163 g

consisting parts:
key GA031R





GB882R

GB716R

DRILL ATTACHMENT

with Jacobs chuck 0.5 - 4 mm

0 - 1,250 rpm; 1.5 Nm;  3.2 mm;
76 x 22 mm;  100 g

consisting parts:
key GA062R





GB884R

GB716R

DRILL ATTACHMENT

with small AO chuck

0 - 1,250 rpm; 1.5 Nm;  2.8 mm;
60 x 22 mm;  66 g





GB886R

GB716R

DRILL ATTACHMENT

with AESCULAP® hexagonal chuck

0 - 1,250 rpm; 1.5 Nm;  3.2 mm;
57 x 24 mm;  67 g





GB887R

GB716R

DRILL ATTACHMENT

with Dental shank

0 - 1,250 rpm; 1.5 Nm;  1.8 mm;
56 x 22 mm;  50 g



AESCULAP® Acculan 4

SMALL DRILL ATTACHMENTS

GB878R

GB716R

ADAPTOR

for Synthes radiolucent drive 511.300

0 - 1,250 rpm; 1.5 Nm;
111 x 27 mm; 181 g



GB894R

GB716R

K-WIRE ATTACHMENT

for K-wires from 0.6 - 3.2 mm

0 - 1,250 rpm; 3.2 mm;
92 x 27 x 124 mm; 179 g



GB891R

GB716R

SAGITTAL SAW ATTACHMENT

for "L-sagittal" sawblades with a
maximum usable length of 50 mm

0 - 15,750 rpm; 74 x 33.5 mm;
4.5°; 179 g



GB892R

GB716R

RECIPROCATING SAW ATTACHMENT

for reciprocating saw blades

0 - 15,750 rpm; 135 x 24.5 mm;
166 g; 2.5 mm





GB896R

GB716R

SCREW ATTACHMENT

with small AO chuck

0 - 165 rpm; 10 Nm;  1.7 mm;
95 x 28 x 129.5 mm;  235 g





GB897R

GB716R

SCREW ATTACHMENT

with AESCULAP® hexagonal chuck

0 - 165 rpm; 10 Nm;  1.7 mm;
95 x 28 x 129.5 mm;  231 g



AESCLAP[®] Acculan 4

CHARGER & BATTERIES

GA320

Acculan 4 CHARGER

for Acculan Li-Ion and NiMH batteries
GA346, GA676; 4 charging bays;
automatic battery diagnosis function;
power cord not included

100 - 240 V AC; 50 / 60 Hz;
410 x 120 x 160 mm; 2,300 g



GA346

Acculan 4 LI-ION BATTERY SHORT

only for GA340, GA341 and GA344;
with integrated electronic motor
control 9.9 V; 10.89 Wh

120 x 43 x 50 mm; 265 g



GA676

Acculan NIMH BATTERY

only for GA330, GA331, GA334,
GA336, GA337; with integrated elec-
tronic motor control 9.6 V; 1.95 Ah

140 x 43 x 50 mm; 425 g



GA679

GB489R

Acculan BATTERY REMOVAL DEVICE



GA675

GB487R

Acculan LID

90 g



GA678

GB488R

Acculan STERILE FUNNEL



AESCULAP® Acculan 4 Electro

LOOK. FEEL. EXPERIENCE.

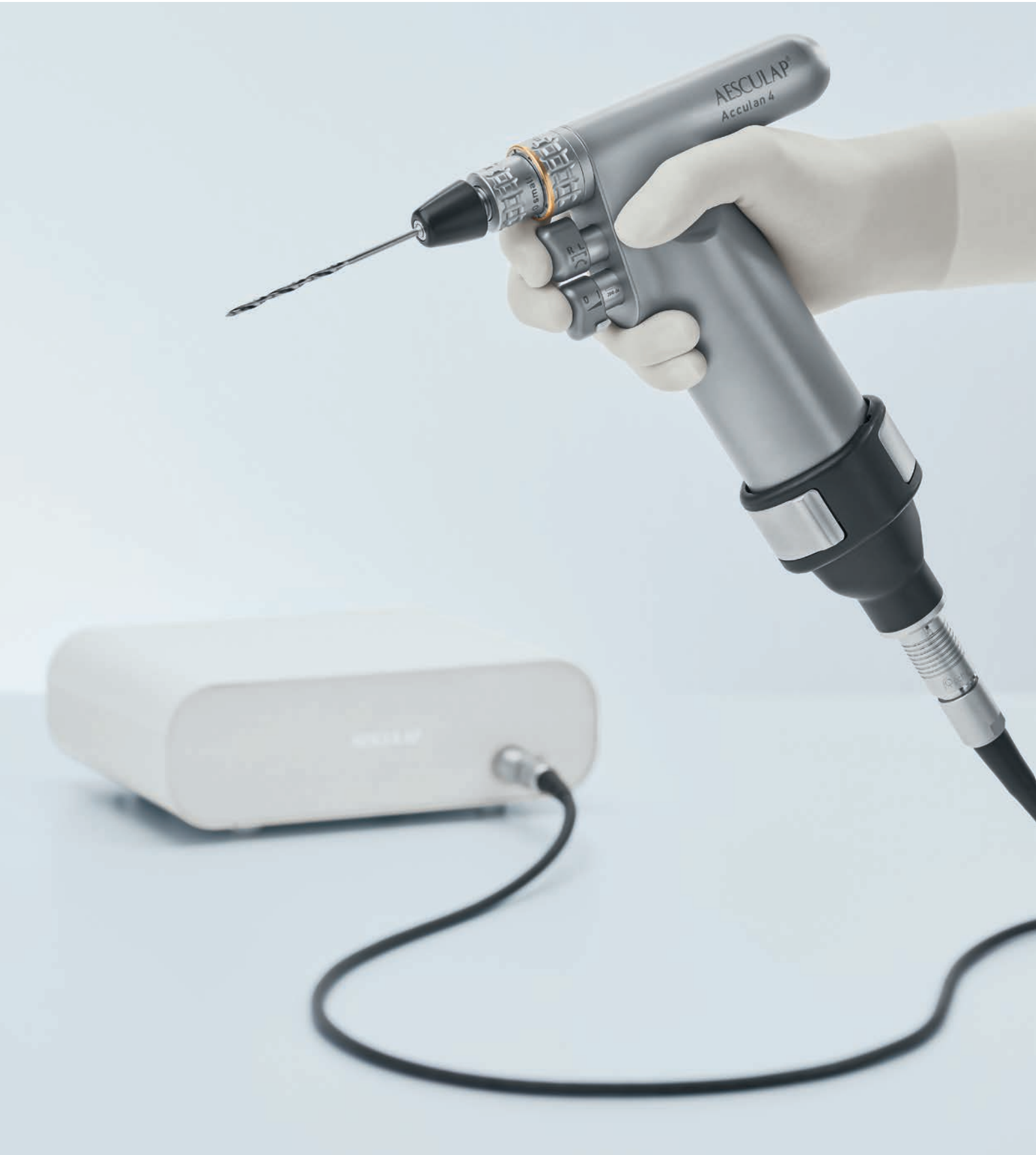

CONSOLE & BATTERIES

GA877

Acculan Electro CONSOLE
 power cord not included
 100 - 240 V AC; 50 / 60 Hz;
 255 x 217 x 90 mm; 2,930 g



GA878

GB486R

Acculan Electro CONNECTION CABLE
 for use with Acculan 4 handpieces
 3.0 m; 410 g



GA875

GB485R

Acculan Electro LID



GA876

Acculan Electro ADAPTOR
 120 x 49 x 42 mm; 165 g



GA678



GB488R

Acculan STERILE FUNNEL



AESCULAP® Acculan 4 ACCESSORIES

ADAPTORS, KEYS & POWER CORD

<p>GB176R GB467R</p> <p>ZIMMER ADAPTOR</p> <p>tool: Zimmer motor: Hudson/Zimmer only in combination with GB630R, GB656R, GB665R, GB669R or GB872R</p> <p> 3.8 mm</p>	<p>GB628R GB690R</p> <p>SYNTHES DHS/DCS ADAPTOR</p> <p>tool: Synthes DHS/DCS motor: AO large</p> <p> 4.2 mm</p>	<p>GB184R GB690R</p> <p>HARRIS ADAPTOR</p> <p>tool: Harris motor: AO large</p> <p> 3.5 mm</p>
		
<p>XF457R GB690R</p> <p>DIN ADAPTOR</p> <p>tool: DIN motor: AO large</p> <p> 3.8 mm</p>	<p>GA031R</p> <p>KEY</p> <p>for large Jacobs chuck suitable for GB620R, GB621R, GB667R, GB870R, GB881R</p>	<p>GA062R GB690R</p> <p>KEY</p> <p>for small 4 mm Jacobs chuck suitable for GB639R, GB882R</p>
		
<p>TE780</p>		
<p>POWER CORD</p> <p>Europe,  1.5 m</p>		
<p>TE730</p>		
<p>POWER CORD</p> <p>Europe,  5.0 m</p>		
<p>TE734</p>		
<p>POWER CORD</p> <p>UK,  5.0 m</p>		
<p>TE735</p>		
<p>POWER CORD</p> <p>USA, Canada, Japan,  3.5 m</p>		

AESCU LAP[®] PROCESSING

Sterilit[®] POWER SYSTEMS



AESFULAP® MECHANICAL PROCESSING

- The solution for storage and mechanical reprocessing of our AESFULAP® Power Systems.
- For detailed information please refer to the Instruction for Use.



AESULAP[®] MECHANICAL PROCESSING

ECCOS[®] SETS

ELAN 4

GB261R

ELAN 4 electro ECCOS[®] SET

 106 mm

consisting parts:

GB073R

GB076R

GB083R

GB085R

GB719R

GB072R

JF212R

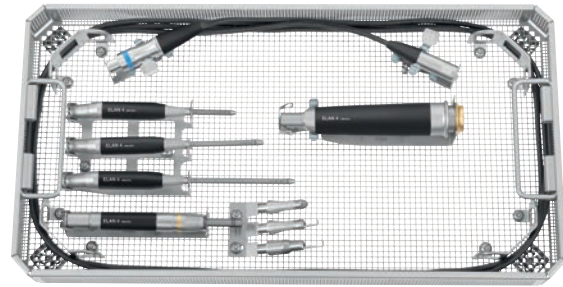

GB262R

ELAN 4 electro ECCOS[®] SET FOR DRILL GA844

 106 mm

consisting parts:

GB072R

GB073R

GB482R

GB715R

GB716R







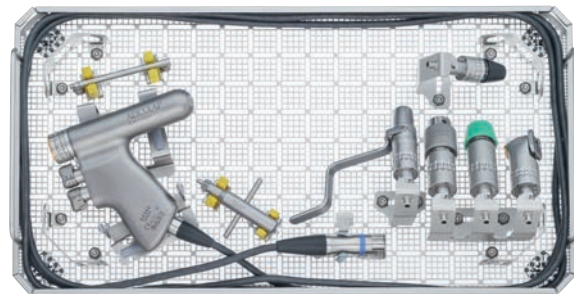



















JG340

JG342

JG344











ECCOS®
ELAN 4 electro

<p>GB073R</p> <p>ECCOS® HOLDER for motor cable GA804, GA805, GA806 (set consisting of 2 pieces)</p>  56 mm	<p>GB076R</p> <p>ECCOS® HOLDER for perforator driver GA822</p>  56 mm	<p>GB077R</p> <p>ECCOS® HOLDER for intra motor GA824</p>  56 mm
 	 	 
<p>GB082R</p> <p>ECCOS® HOLDER for 1 handpiece</p>  56 mm	<p>GB083R</p> <p>ECCOS® HOLDER for 3 handpieces</p>  56 mm	<p>GB085R</p> <p>ECCOS® HOLDER for craniotome GA849</p>  56 mm
 	 	 
<p>GB086R</p> <p>ECCOS® HOLDER for micro sagittal saw GA836</p>  56 mm	<p>GB087R</p> <p>ECCOS® HOLDER for reciprocating saws GA832, GA837</p>  56 mm	<p>GB088R</p> <p>ECCOS® HOLDER for saws GA831, GA833</p>  56 mm
 	 	 

AESULAP[®] MECHANICAL PROCESSING

ECCOS[®]

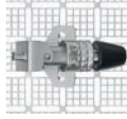
ELAN 4 electro

GB482R	GB715R	GB716R
<p>ECCOS[®] HOLDER for ELAN 4 electro drill GA844</p>  106 mm	<p>ECCOS[®] HOLDER for 1 attachment GB870R, GB871R, GB872R, GB878R, GB881R, GB884R, GB892R, GB896R, GB897R</p>  106 mm	<p>ECCOS[®] HOLDER for 3 attachments GB870R, GB871R, GB872R, GB878R, GB881R, GB884R, GB892R, GB896R, GB897R</p>  106 mm
		
		

ECCOS® & RINSING DEVICES

ELAN 4 electro

GB084R

ECCOS® HOLDER

for MIS handpiece GA860

 56 mm

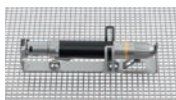

GB723R

ECCOS® HOLDER

for MIS handpiece shafts GB920R - GB927R

 56 mm



GB692R

RINSING DEVICE

for applied parts, incl. ceramic filter GB693R
(not suitable for autoclaving)

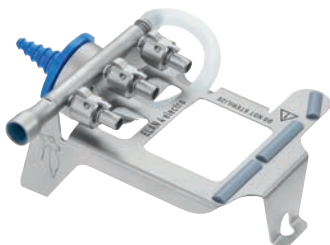

GB679R

RINSING DEVICE

for 4 MIS shafts, incl. ceramic filter GB693R
(not suitable for autoclaving)

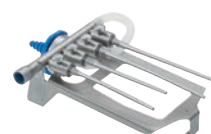
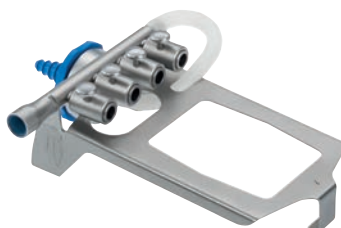

GB698R

RINSING ADAPTOR

for applied parts
(for manual cleaning)



GB699R

RINSING ADAPTOR



for MIS shafts
(for manual cleaning)



AESCALAP[®] MECHANICAL PROCESSING

ECCOS[®]

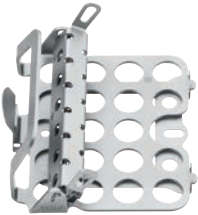
ELAN 4 ACCESSORIES

<p>GB718R</p>	<p>GB719R</p>	<p>GB720R</p>
<p>ECCOS[®] HOLDER for 12 1- and 2-ring burrs  56 mm</p>	<p>ECCOS[®] HOLDER for 3 craniotome attachments  56 mm</p>	<p>ECCOS[®] UNIVERSAL HOLDER for saw blades  56 mm</p>
		
		
<p>GB729R</p>	<p>GB730R</p>	<p>GB072R</p>
<p>ECCOS[®] HOLDER for 2 reciprocating saw shafts  56 mm</p>	<p>ECCOS[®] HOLDER for 2 transversal saw shafts  56 mm</p>	<p>ECCOS[®] CABLE/HOSE POS. GUIDE for cable and hoses (set of 4 pieces)  56 mm</p>
		
		
<p>GB727R</p>	<p>GB572R</p>	
<p>ECCOS[®] HOLDER for handpiece holding-sleeves GB861P, GB862P, GB863P  56 mm</p>	<p>ECCOS[®] FIXATION for GB300R - GB308R  56 mm</p>	
		
		

ECCOS® SETS

Acculan 4

GB257R

ECCOS® SET

for Acculan 4 small drill GA344

 106 mm

consisting parts:

GB482R

GB487R

GB488R

GB715R

GB716R

JG340

JG342

JG344

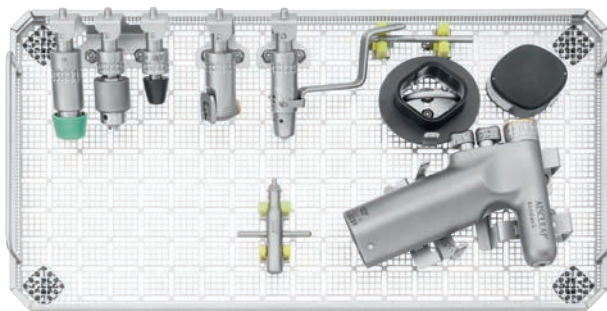

GB243R

ECCOS® SET

for 2 Acculan 4 machines

 106 mm

consisting parts:

GB481R

GB487R

GB488R

GB495R

GB496R

GB497R

GB690R

JG340

JG342

JG344

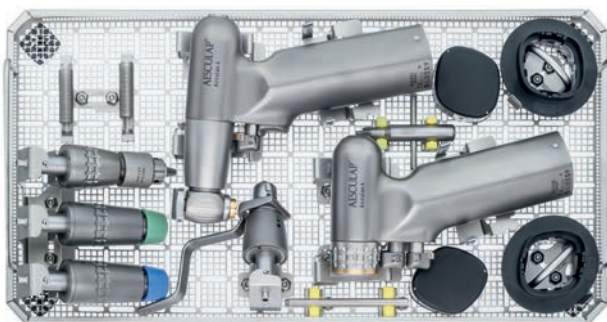

GB256R

ECCOS® SET

for Acculan 4 dermatome

 106 mm

consisting parts:

GB487R

GB488R

GB498R



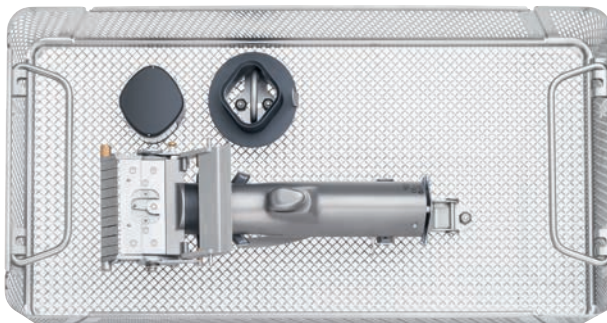











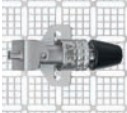

JJ464R



AESCALAP[®] MECHANICAL PROCESSING

ECCOS[®]

Acculan 4













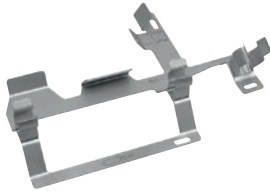

<p>GB482R</p>	<p>GB715R</p>	<p>GB716R</p>
<p>ECCOS[®] HOLDER for Acculan 4 small drill GA344  106 mm</p>	<p>ECCOS[®] HOLDER for 1 attachment GB870R, GB871R, GB872R, GB878R, GB881R, GB884R, GB892R, GB896R, GB897R  106 mm</p>	<p>ECCOS[®] HOLDER for 3 attachments GB870R, GB871R, GB872R, GB878R, GB881R, GB884R, GB892R, GB896R, GB897R  106 mm</p>
		
		
<p>GB495R</p>	<p>GB496R</p>	<p>GB497R</p>
<p>ECCOS[®] HOLDER for GA330, GA331, GA334  106 mm</p>	<p>ECCOS[®] HOLDER for GB620R, GB621R, GB623R, GB639R, GB641R, GB645R GB660R, GB663R, GB664R, GB665R, GB657R, GB667R, GB668R, GB669R, GB670R  106 mm</p>	<p>ECCOS[®] HOLDER for GB620R, GB621R, GB623R, GB639R, GB641R, GB645R GB660R, GB663R, GB664R, GB665R, GB657R, GB667R, GB668R, GB669R, GB670R  106 mm</p>
		
		

<p>GB487R</p>	<p>GB488R</p>	<p>GB489R</p>
<p>ECCOS® HOLDER for GA675  56 mm</p>	<p>ECCOS® HOLDER for GA678  76 mm</p>	<p>ECCOS® HOLDER for GA679  106 mm</p>
 	 	 
<p>GB498R</p>	<p>GB686R</p>	
<p>ECCOS® HOLDER for GA336, GA337, GA340, GA341  106 mm</p>	<p>ECCOS® HOLDER for GB436R  56 mm</p>	
 	 	

AESCULAP® MECHANICAL PROCESSING

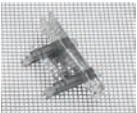
ECCOS® HOLDER

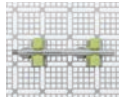
Acculan 4

GB485R	GB486R	GB688R
<p>ECCOS® HOLDER for GA875</p>  56 mm	<p>ECCOS® HOLDER for GA878</p>  56 mm	<p>ECCOS® HOLDER for BA720R</p>  106 mm
 	 	 
GB481R	GB690R	GB459R
<p>ECCOS® HOLDER for saw blades and other accessories</p>  56 mm	<p>ECCOS® HOLDER 5 mm for drilling wire guide GA672207, GA344244</p>	<p>ECCOS® MOUNTING KIT</p>
 	 	
JF148R		
<p>MINI TRAY WITH LID</p> <p>outer size: 145 x 44 x 25 mm inner size: 140 x 39 x 18 mm</p> <p>for storage of Acculan 4 Dermatome rod and flaps during automatic cleaning process</p>		
		

ECCOS® HOLDER

Universal Tools

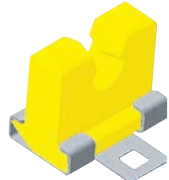
JG303R	JG342 / JG344
REPLACEMENT SCREWS-SET	SILICONE CLAMP 8.5 mm / 12 mm screw JG303R to be ordered separately
	

AESCALAP® POWER SYSTEMS

TOOL ATTACHMENTS OVERVIEW

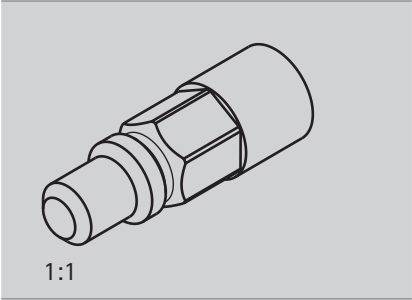

AO LARGE

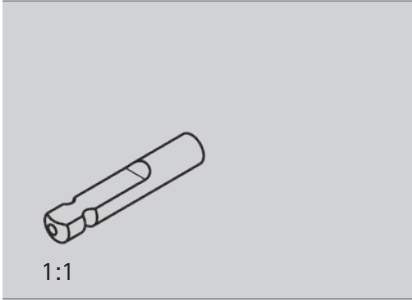

AO SMALL

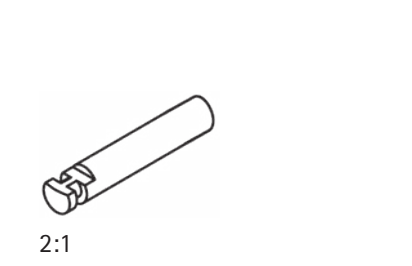

DENTAL

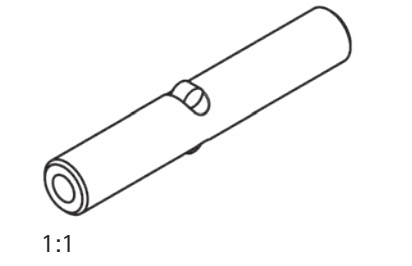

DIN

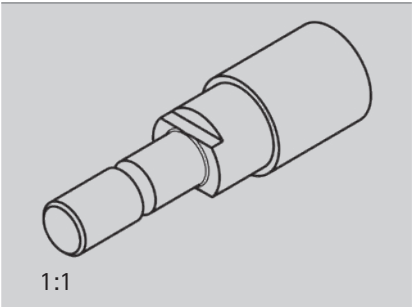

HARRIS

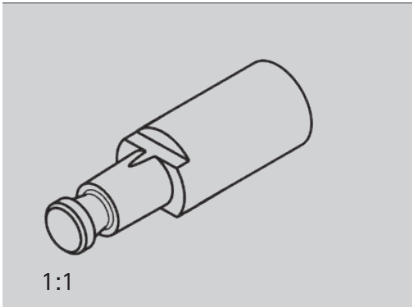

HUDSON

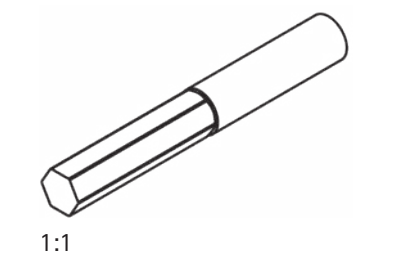

HEXAGON

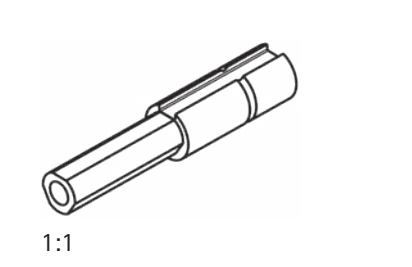

SYNTHES
DHS/DCS

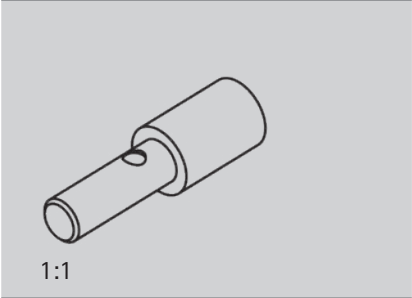



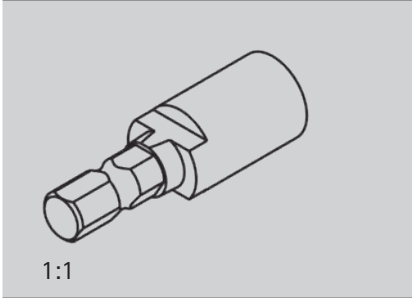



TRINKLE

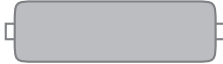

ZIMMER

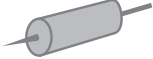
SIGNS & SYMBOLS

	<p>LATEX-FREE All products listed in this catalogue are latex-free</p>
	<p>ARTICLE CODE ECCOS® FIXATION</p>
	<p>FORWARD / REVERSE DRIVE</p>
	<p>FORWARD DRIVE</p>
	<p>OSCILLATION FREQUENCY</p>
	<p>OSCILLATION ANGLE</p>
	<p>STROKE</p>
	<p>CANNULATION</p>
	<p>CABLE LENGTH</p>
	<p>WEIGHT</p>
	<p>PACKAGING UNIT</p>
	<p>SINGLE USE</p>
	<p>REQUIRED HEIGHT OF TRAY</p>
	<p>STERILE</p>

AESCLAP[®] POWER SYSTEMS

BROCHURES

Main Catalogues

084002 Power Systems



017599 Burs & Blades



ELAN 4

071602 ELAN 4

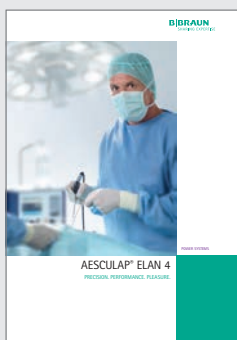

071511 Mechanical Cleaning



012002 Manual Cleaning



Acculan 4

001802 Acculan 4

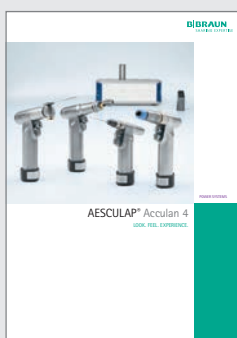

001902 Acculan 4 Dermotome

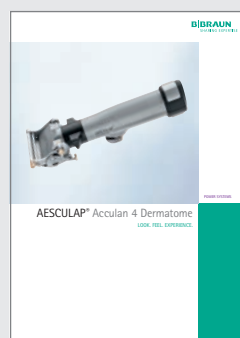

002002 Acculan 4 Electro

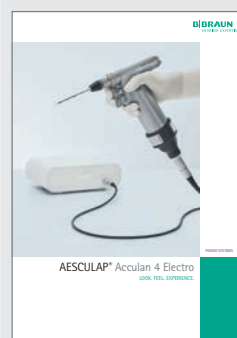

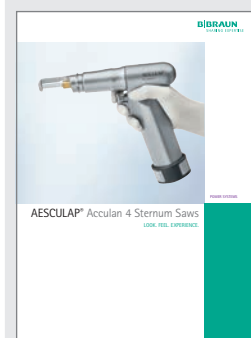

002102 Acculan 4 Sternum Saws



INDEX

Art. No.	
BA720R	32
GA031R	42
GA062R	42
GA258SU	23
GA259SU	23
GA261SU	23
GA262SU	23
GA263SU	23
GA264SU	23
GA265SU	23
GA266SU	23
GA267SU	23
GA268SU	23
GA269SU	23
GA320	38
GA330	26
GA331	30
GA334	31
GA336	30
GA337	30
GA340	32
GA341	32
GA344	34
GA346	38
GA395SU	23
GA675	38
GA676	38
GA678	38, 41
GA679	38
GA800	7
GA804	8
GA805	8
GA806	7
GA808	7
GA810	7
GA822	8
GA824	8
GA831	15
GA832	15
GA833	15
GA836	15
GA837	15
GA844	17
GA849	9
GA860	13
GA861	10
GA862	10
GA863	10
GA864	10
GA865	11

Art. No.	
GA866	11
GA867	11
GA868	11
GA869	11
GA875	41
GA876	41
GA877	41
GA878	41
GB072R	50
GB073R	47
GB076R	47
GB077R	47
GB082R	47
GB083R	47
GB084R	49
GB085R	47
GB086R	47
GB087R	47
GB088R	47
GB176R	42
GB184R	42
GB243R	51
GB256R	51
GB257R	51
GB261R	46
GB262R	46
GB436R	31
GB459R	54
GB481R	54
GB482R	48, 52
GB485R	54
GB486R	54
GB487R	53
GB488R	53
GB489R	53
GB495R	52
GB496R	52
GB497R	52
GB498R	53
GB572R	50
GB600	44
GB600840	44
GB600860	44
GB600870	44
GB600880	44
GB620R	26
GB621R	26
GB623R	26
GB628R	42
GB639R	27

Art. No.	
GB641R	29
GB645R	27
GB657R	28
GB660R	29
GB663R	27
GB664R	27
GB665R	27
GB667R	28
GB668R	28
GB669R	28
GB670R	28
GB679R	49
GB686R	53
GB688R	54
GB690R	54
GB692R	49
GB698R	49
GB699R	49
GB715R	48, 52
GB716R	48, 52
GB718R	50
GB719R	50
GB720R	50
GB723R	49
GB727R	50
GB729R	50
GB730R	50
GB796SU	23
GB797SU	23
GB861P	22
GB862P	22
GB863P	22
GB866R	22
GB870R	17, 34
GB871R	17, 34
GB872R	17, 34
GB878R	19, 36
GB881R	18, 35
GB882R	18, 35
GB884R	18, 35
GB886R	18, 35
GB887R	18, 35
GB891R	19, 36
GB892R	19, 36
GB894R	19, 36
GB896R	20, 37
GB897R	20, 37
GB920R	13
GB921R	13
GB922R	13

Art. No.	
GB925R	13
GB926R	13
GB927R	13
GB941R	9
GB942R	9
GB943R	9
GB945R	9
GB947R	9
JF148R	54
JF212R	46
JG303R	55
JG342	55
JG344	46, 55
TE730	22, 42
TE734	22, 42
TE735	22, 42
TE780	22, 42
XF457R	42

AESCULAP® – a B. Braun brand

Aesculap AG | Am Aesculap-Platz | 78532 Tuttlingen | Germany
Phone +49 7461 95-0 | Fax +49 7461 95-2600 | www.aesculap.com

The main product trademark "AESCULAP" and the product trademarks "ECCOS" and "Sterilit" are registered trademarks of Aesculap AG.

Subject to technical changes. All rights reserved. This brochure may only be used for the exclusive purpose of obtaining information about our products. Reproduction in any form partial or otherwise is not permitted.